

412



MODEL NO	PASLANMAZ (STAINLESS)	SİYAH (BLACK)	F1 (N)	F3 (N)	STROK (DİŞ BOYU) (STROKE) (thread length)	AĞIRLIK (WEIGHT) (gr)
412 - 2	S 412 -	B 412 -	1500	1800	35	210
412 - 3	S 412 -	B 412 -	2000	2500	41	325
412 - 4	S 412 -	B 412 -	3500	4000	55	860

F1 : BASKI KUVVETİ (EXERTING FORCE) , F3 : TUTMA KAPASİTESİ (HOLDING CAPACITY)
Paslanmaz C Kancalı ürünlerin çekme kuvvetleri %30 daha azdır. (Stainless stell latch clamp's tensile strength are %30 more less)



Ayak Tipi: Dikey Tabanlı
Body Mounting Base: Vertical

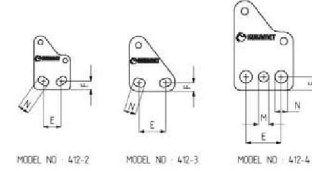
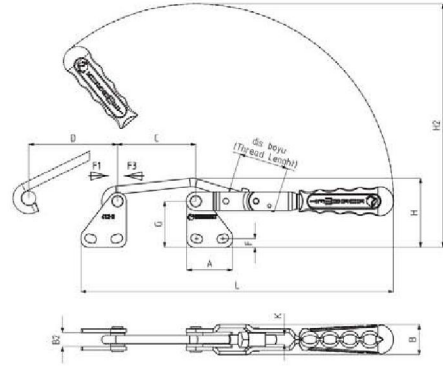

MODEL NO	A	B	B2	C Min.	C Max.	D	E	F	G	H	H2	J	K	L Min.	L Max.	M	N
412 - 2	31	21,5	10	45	60	50	12 - 18	6 - 8	40	52	169	9	M6	200	215		6 x 9,5
412 - 3	38,5	25,5	12	60	75	80	19 - 25	7 - 7,5	39	57	205	12	M 8	255	270		7x10
412 - 4	50	34	16	75	100	130	30	11,5	67	88	280	16	M10	335	360	Ø 8,5	Ø 10,5

413



MODEL NO	PASLANMAZ (STAINLESS)	SİYAH (BLACK)	F1 (N)	F3 (N)	STROK (DİŞ BOYU) (STROKE) (thread length)	AĞIRLIK (WEIGHT) (gr)
413 - 3	S 413 -	B 413 -	2000	2500	41	285

F1 : BASKI KUVVETİ (EXERTING FORCE) , F3 : TUTMA KAPASİTESİ (HOLDING CAPACITY)
Paslanmaz C Kancalı ürünlerin çekme kuvvetleri %30 daha azdır. (Stainless stell latch clamp's tensile strength are %30 more less)



Ayak Tipi: U Tabanlı
Body Mounting Base: U Base

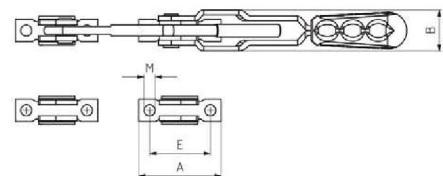
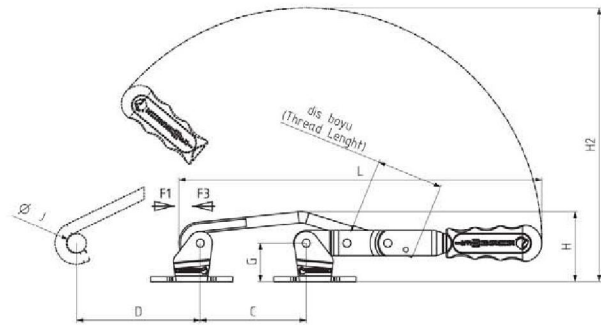

MODEL NO	A	B	B2	C Min.	C Max.	D	E	F	G	H	H2	J	K	L Min.	L Max.	M	N
421 - 3	51,5	25,5		60	75	80	38		24	42	190	12	M 8	255	270	Ø 7	